

# Time-Delayed Safety Relay SRTC

## User Information

English translation

### Correct Use

The SRTC is an expansion module that can be operated with any basic device from the ZANDER SR series, e.g. SR2C or SR3C, in order to permit delayed switch-off of machine parts. This could be the case if it is safer to return a tool to its initial position first instead of stopping operation immediately, for example. The SRTC was developed as a component for a modular system. Any combination of SRTC units and non-time-delayed SREC expansion blocks can be interconnected with just a few lines, permitting realization of an overall system with different times and the specific number of safety contacts required.



(not for plug-in terminals)

### Features

- 3 safe, redundant, time-delayed relay outputs
- 1 auxiliary contact (fault monitoring)
- Activation via basic device from the ZANDER SR series
- Continuously adjustable delay, 1 to 30s
- Modular, freely configurable safety system
- Corresponds to STOP category 1
- Fault monitoring by basic device
- Indication of the switching state via LED
- Up to PL d, category 3, SILCL 2

### Function

The time-delayed emergency stop safety switching device SRTC in combination with a basic device from the ZANDER SR series is designed for safe isolation of safety circuits according to EN 60204-1 and can be used up to safety category 3, PL d according to EN ISO 13849-1.

The SRTC provides a control voltage of DC 24V at terminal S11. In order for the SRTC to switch together with the connected basic device, the control voltage at S11 is connected to terminals S15 and S16 of the SRTC via one of the safety contacts of the basic device (see *Wiring* section on page 2).

The safety contacts of the basic device close when the basic device is activated, and the DC 24V control voltage at terminal S11 is then connected with terminals S15 and S16 of the SRTC. The safety contacts of the SRTC switch immediately.

The basic device disconnects the control voltage when the safety switch is operated, and the safety contacts of the SRTC open after the time set on the SRTC elapses (the power supply must be present during the time sequence).

If a fault occurs in the SRTC, this is detected by the basic device via terminals S25 and S26.

**Independent operation without basic device is not possible.**

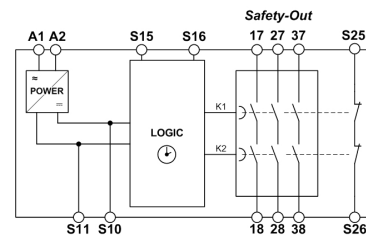

Fig. 1 Block diagram SRTC

### Installation

As per EN 60204-1, the device is intended for installation in control cabinets with a minimum degree of protection of IP54. It is mounted on a 35-mm DIN rail according to DIN EN 60715 TH35.

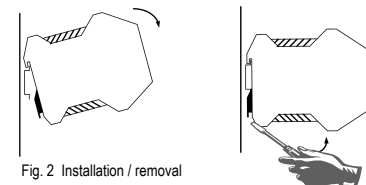

Fig. 2 Installation / removal

### Safety Precautions



- Installation and commissioning of the device must be performed **only by authorized personnel**.
- Observe the country-specific regulations when installing the device.
- The electrical connection of the device is only allowed to be made with the device isolated.
- The wiring of the device must comply with the instructions in this user information, otherwise there is a risk that the safety function will be lost.
- It is not allowed to open the device, tamper with the device or bypass the safety devices.
- All relevant safety regulations and standards are to be observed.
- The overall concept of the control system in which the device is incorporated must be validated by the user.
- Failure to observe the safety regulations can result in death, serious injury and serious damage.

### Electrical Connection

- When the 24V version is used, a control transformer according to EN 61558-2-6 or a power supply unit with electrical isolation from the mains must be connected.
- External fusing of the safety contacts (4 A slow-blow or 6 A quick-action or 10 A gG) must be provided.
- A maximum length of the control lines of 1000 meters with a line cross section of 0.75 mm<sup>2</sup> must not be exceeded.
- The line cross section must not exceed 2.5 mm<sup>2</sup>.
- If the device does not function after commissioning, it must be returned to the manufacturer unopened. Opening the device will void the warranty.

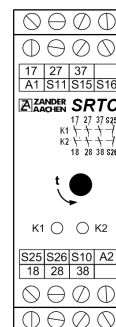

- A1: Power supply
- A2: Power supply
- S11: DC 24V control voltage
- S10: Control line
- S15: Control line
- S16: Control line
- S25: Fault monitoring
- S26: Fault monitoring
- 17-18: Time-delayed safety contact 1
- 27-28: Time-delayed safety contact 2
- 37-38: Time-delayed safety contact 3

Fig. 3 Connections

B09  
B101

E61-145-00

## User Information

### Applications

Depending on the application, the device must be wired with a ZANDER basic device as shown in Fig. 1 to Fig. 6.

### Wiring

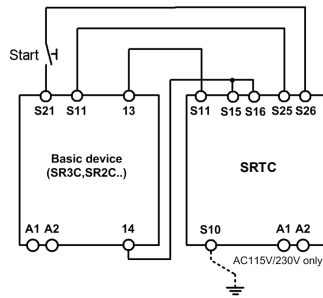

**Fig. 1: Connection of SRTC to Basic Device**

**Wiring of the SRTC via only 4 lines:**  
A safety contact of the ZANDER basic device (e.g. 13-14) activates the relays of the SRTC (S11 and S15/S16). Two lines on S25 and S26 are required for feedback/fault monitoring. A fault in the SRTC thereby prevents the entire safety chain from restarting. Earth faults in the control lines are detected in addition to internal faults.

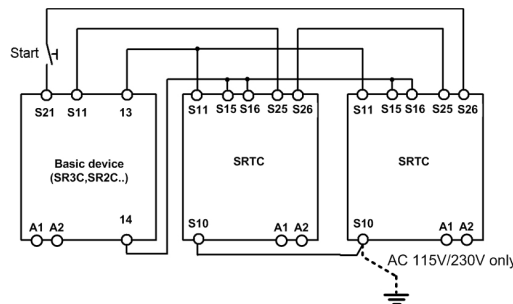

**Fig. 2: Connection of several SRTC Units to Basic Device**

If further SRTC units are to be integrated into the system, terminals S11 must be connected in parallel on all SRTC units. This also applies to terminals S10 and terminals S15/S16.

### Notice:

In order to activate earth fault monitoring, S10 must be connected to PE (protective earth) on the AC-115/230V devices. With AC/DC 24V, connect PE only to the power supply unit according to EN60204-1.

### Feedback Loop

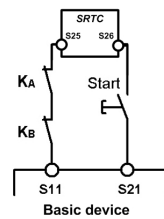

**Fig. 3: Feedback loop**

Contacts connected to the SRTC or the basic devices are monitored via the feedback loop of the basic device. KA and KB are the positively driven contacts of the connected contactor or expansion module.

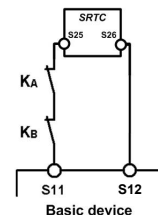

**Fig. 4: Feedback Loop with Auto-Start**

Contacts connected to the SRTC or the basic devices are monitored via the feedback loop of the basic device. KA and KB are the positively driven contacts of the connected contactor or expansion module.

### Power supply and Safety contacts

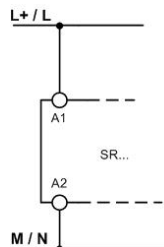

**Fig. 5:**  
Power supply A1 and A2.

(Power supply according to techn. Data)

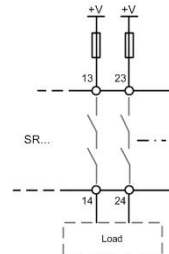

**Fig. 6:**  
Connecting load to safety contacts.

(Figure shows example. Voltage „+V“ according to techn. Data)

### Commissioning Procedure

**Note:** The items listed under “Electrical connection” must be observed during commissioning.

#### 1. Wiring SRTC:

Wire the SRTC with the ZANDER basic device according to your application (see Fig. 1 to Fig. 2).

#### 2. Wiring basic device:

Wire the basic device according to the required Performance Level determined (see user information for the basic device).

#### 3. Wiring feedback loop:

Wire the feedback loop as shown in Fig. 3 or Fig. 4.

#### 4. Wiring power supply:

Connect the power supply to terminals A1 and A2 (Fig. 5).

**Warning:** Wiring only in de-energized state.

#### 5. Setting delay time:

Set the desired time delay on the rotary knob and seal the knob with the supplied sticker.

#### Warning:

Scale division lines should be regarded only as a setting aid. Always make sure to measure the delay time.

#### 6. Starting the device:

Switch the operating voltage on.

#### Warning:

If the “Automatic start” starting behavior is set on the basic device, the safety contacts will close immediately.

If the “Monitored manual start” starting behavior is set, close the start button on the basic device to close the safety contacts.

The LEDs **K1** and **K2** on the basic device and on the SRTC are lit when the safety contacts are closed.

#### 7. Triggering safety function:

Open the emergency stop circuit by actuating the connected safety switch. The safety contacts of the basic device open immediately; the safety contacts of the SRTC open after expiration of the time set on the rotary knob.

**Warning:** Measure the delay time.

#### 8. Reactivation:

Close the emergency stop circuit. If “Automatic start” is selected on the basic device, the safety contacts will close immediately.

If the “Monitored manual start” starting behavior is set, close the start button on the basic device to close the safety contacts of the basic device and the SRTC.



## User Information

### Maintenance

Once per month, the device must be checked for proper function and for signs of tampering and bypassing of the safety function (to do this, check the wiring of the device and activate the emergency stop function. Check the delay time).

The device is otherwise maintenance free, provided that it was installed properly.

### What to Do in Case of a Fault?

#### Device does not switch on:

- Check the wiring of the SRTC and the basic device by comparing it with the wiring diagrams (also see user information for the basic device).
- Check the safety switch used on the basic device for correct function and adjustment.
- Check whether the emergency stop circuit of the basic device is closed.
- Check whether the start button on the basic device (with manual start) is closed.
- Check the operating voltage at A1 and A2 on the basic device and on the SRTC.
- Is the feedback loop closed?

#### Device cannot be switched on again after an emergency stop:

- Check whether the emergency stop circuit was closed again.
- Was the start button opened before closing of the emergency stop circuit (with manual start)?
- Is the feedback loop closed?
- Is the power supply present during the time sequence?

If the fault still exists, perform the steps listed under "Commissioning Procedure".

If these steps do not remedy the fault either, return the device to the manufacturer for examination.

**Opening the device is impermissible and will void the warranty.**

### Safety Characteristics According to EN ISO 13849-1

The device is certified according to EN ISO 13849-1 up to a Performance Level of PL e.

#### Note:

Additional data can be requested from the manufacturer for applications that deviate from these conditions.

Safety characteristics according to EN ISO 13849-1 for all variants of SRTC			
Load (DC13; 24V)	<= 0,1A	<= 1A	<= 2A
T10d [years]	20	20	20
Category	3	3	3
PL	D	d	d
PFHd [1/h]	1,03E-07	1,03E-07	1,03E-07
nop [cycle / year]	<= 400.000	<= 73.000	<= 17.000

### Techn. Data

Corresponds to the standards	EN 60204-1; EN ISO 13849-1 ; EN 62061
Operating voltage	AC 230V, AC 115V, AC/DC 24V
Rated supply frequency	AC: 50-60Hz
Permissible deviation	+ / - 10%
Power consumption	<b>DC 24V</b> <b>AC 230V</b> approx. 1.5 W    approx. 4 VA
Delay time	1 to 30s, continuously adjustable
Control voltage at S11	DC 24V
Control current S11...S14	max. 40 mA
Safety contacts	3 NO contacts
Auxiliary contacts	1 NC contact; monitoring contact for basic device
Max. switching voltage	AC 250V
Safety contact breaking capacity	AC: 250V, 1,500VA, 6A for ohmic load, 250V, 4A for AC-15 DC: 24V, 30W, 1.25A for ohmic load; 24V, 30W, 2A for DC-13 Max. total current through all 3 contacts: 10.5A
Minimum contact load	24V, 20mA
Min. Contact fuses	4 A slow-blow or 6 A quick-action or 10A gG
Max. line cross section	0.14 - 2.5mm <sup>2</sup>
Max. length of control line	1000m with 0.75mm <sup>2</sup>
Contact material	AgNi
Contact service life	mech. approx. 1 x 10 <sup>7</sup> , electr. 1 x 10 <sup>5</sup> operating cycles
Test voltage	2.5kV (control voltage/contacts)
Rated impulse withstand voltage, leakage path/air gap	4kV (DIN VDE 0110-1)
Rated insulation voltage	250V
Degree of protection	IP20
Temperature range	DC 24V: -15°C to +60°C AC 230/115V: -15°C to +40°C
Degree of contamination	2 (DIN VDE 0110-1)
Overvoltage category	3 (DIN VDE 0110-1)
Weight	approx. 230g
Mounting	DIN rail according to EN 60715TH35

B09  
B101

E61-145-00

## User Information

Dimension Drawing

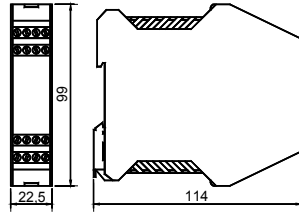

Variants

Order no. 472190	SRTC, AC 230V (50-60Hz), fixed screw terminals
Order no. 472191	SRTC, AC 115V (50-60Hz), fixed screw terminals
Order no. 472192	SRTC, AC/DC 24V (AC: 50-60Hz), fixed screw terminals
Order no. 473190	SRTC, AC 230V (50-60Hz), plug-in terminals
Order no. 473191	SRTC, AC 115V (50-60Hz), plug-in terminals
Order no. 473192	SRTC, AC/DC 24V (AC: 50-60Hz), plug-in terminals
Order no. 472592	EKLS4, set of plug-in screw terminals
Order no. 472593	EKLZ4, set of plug-in tensile spring terminals

## Konformitätserklärung EC Declaration of Conformity



**Hersteller:** H. ZANDER GmbH & Co. KG  
**Producer:** Am Gut Wolf 15 • D-52070 Aachen

**Produktgruppe:** Sicherheits-Not-Aus-Schaltgeräte  
**Product Group:** Safety emergency stop switching devices

**Die Produkte stimmen mit den Vorschriften folgender Europäischer Richtlinien überein:**  
The products conform with the essential protection requirements of the following European directives:

**2006/42/EG** : Maschinenrichtlinie  
2006/42/EG : Machinery directive

**2004/108/EG** : EMV Richtlinie  
2004/108/EG : EMC directive

**2006/95/EG** : Niederspannungsrichtlinie  
2006/95/EG : Low voltage switchgear directive

**Die Übereinstimmung der bezeichneten Produkte mit den Vorschriften der o.a. Richtlinie wird, falls anwendbar, nachgewiesen durch die vollständige Einhaltung folgender Normen:**  
If applicable, the conformity of the designated products is proved by full compliance with the following standards:

EN 60439-1:2005-01	EN 60947-1:2008-04	EN 60947-5-1:2005-02
EN 60947-7-1:2003-07	EN 61000-6-2:2006-03	EN 61000-6-3:2005-05
DIN EN 61326-3-1:2008-11	DIN EN ISO 13849-1:2008-12	DIN EN ISO 13849-2:2003
IEC 62061:2005-10		

Produkt Name Product Name	Anbringung der CE-Kennzeichnung Affixing of CE marking:	Zertifikats-Nr. No of Certificate
SRTC	2009	968/EZ 380.00/09
SREC	2010	968/EZ 385.00/09

Produkt Name Product Name	Anbringung der CE-Kennzeichnung Affixing of CE marking:	Zertifikats-Nr. No of Certificate

Benannte Stelle:  
TÜV Rheinland Industrie Service GmbH  
Geschäftsfeld ASI  
Am Grauen Stein  
51105 Köln

Dokumentationsbeauftragter: Christiane Nittschalk  
(Documentation manager)

Aachen, den 15.12.2009

Dipl.-Ing. Walter Zander  
Geschäftsleitung  
(General Manager)

Dipl.-Ing. Alfons Austerhoff  
Leiter CE-Konformitätsbewertung  
(Manager for EC declaration of conformity)

B09  
B101  
E61-145-00