

**Pyrometer with fiber optics for non-contact measurements on metals, ceramics, graphite etc. with temperature ranges between 250 and 3500°C**

**IS 50-LO plus • IGA 50-LO plus**



- Very short response time below 1 ms
- Extremely small spot sizes, min. 0.45 mm
- Built-in LC display
- Laser targeting light
- Parameter adjustments via integrated key pad or interface
- Interface RS232 / RS485 switchable
- Test current output



The pyrometers **IS 50-LO plus** and **IGA 50-LO plus** are digital, highly accurate pyrometers with fiber optics for non-contact temperature measurement on metals, ceramics, graphite etc. between 250° and 2500°C.

The **IS 50/67-LO plus** is a special version with an extremely short wavelength where molten metal has a very high emissivity.

The instrument type **IS 50-Si-LO plus** is optimized for measurements on silicon wafers, e.g. in vacuum chambers.

The **IS 50-AI-LO plus** is specially designed for measurements on aluminum parts and profiles.

The instrument is equipped with a fibre and an exchangeable optical head. The fiber and optical head are unaffected by electromagnetic interferences (e.g. induction) and can be used in high ambient temperatures up to 250°C.

Two different types of optical heads for different measuring distances and very small spot sizes are available. A laser targeting light enables the exact alignment onto the measuring object.

The very short response time of below 1 ms facilitates the measurement of fastest heating processes.

The pyrometer is equipped with a display which shows in measuring

mode the current temperature. Additionally all parameters can be read if they are changed via the integrated keys at the instrument.

Via serial interface and the provided software *InfraWin* the temperature can be displayed and stored on a PC, parametrizing can also be done.

**Typical field of application:**

- metal moulds
- pressing tools
- bearings, bearing housings
- preheating
- annealing
- tempering
- sintering
- soldering
- rolling
- brazing
- normalizing

## Technical Data

Temperature ranges:	<b>IS 50-LO plus:</b> 550 - 1400°C (MB 14) 600 - 1600°C (MB 16) 650 - 1800°C (MB 18) 750 - 2500°C (MB 25) 900 - 3300°C (MB 33) 550 - 1800°C (MB 18L) <b>IS 50/67-LO plus:</b> 1100 - 3500°C (MB 35) <b>IS 50-AI-LO plus:</b> 400 - 1000°C (MB 10)	<b>IGA 50-LO plus:</b> 300 - 1300°C (MB 13) 350 - 1800°C (MB 18) 450 - 2500°C (MB 25) 250 - 1350°C (MB 13,5L) 300 - 2000°C (MB 20L) 350 - 2500°C (MB 25L) <b>IS 50-Si-LO plus:</b> 400 - 1300°C (MB 13) 500 - 1600°C (MB 16)
Subrange:	Any range adjustable within the temperature range, minimum span 51°C	
Spectral range:	IS 50-LO plus: 0.7 - 1.1 µm; IS 50-Si-LO plus; IS 50-AI-LO plus: narrow band in the near infrared IS 50/67-LO plus: 0.676 µm IGA 50-LO plus: 1.45 - 1.8 µm	
IR detector:	IS 50-LO plus; IS 50/67-LO plus; IS 50-Si-LO plus; IS 50-AI-LO plus: Silicon photo diode (Si) IGA 50-LO plus: Indium Gallium Arsenide photo diode (InGaAs)	
Signal processing:	Photo current, digitized immediately	
Power supply:	24 V AC or DC (12 - 30 V AC or DC) (AC: 48 - 62 Hz)	
Power consumption:	Max. 2 W	
Analog output:	0 - 20 mA or 4 - 20 mA (linear), switchable; load: 0 - 500 Ω	
Test current output:	Fixed 10 mA (for 0 to 20 mA analog output) or fixed 12 mA (for 4 to 20 mA analog output) for inspection of wiring and connected instruments	
Serial interface:	Switchable: RS232 or RS485 (addressable), half duplex, baud rate 1.2 up to 115 kBd	
Resolution:	Interface and display: 0.1°C, analog output: < 0.1 % of the adjusted temperature range	
Isolation:	Power supply, digital interface, analog output are galvanically isolated against each other	
Display:	Illuminated LC display for temperature indication or parameter settings	
Parameters:	Adjustable at the instrument or via serial interface: emissivity; exposure time; analog output; address; baud rate; waiting time; °C or °F; setting of the maximum value storage; temperature sub range	
Emissivity ε:	20 ... 100% adjustable inside the instrument or via interface in steps of 0.1%	
Exposure time t <sub>90</sub> :	< 1 ms; adjustable to 0.01 s; 0.05 s; 0.25 s; 1 s; 3 s; 10 s	
Maximum value storage:	Single or double storage; cleared by: preselected time interval or external deletion contact or via digital interface or automatically with the next measuring object	
Switch contact:	Max. 0.15 A (to recognize a hot object in the measuring beam)	
Meas. uncertainty: (ε = 1, t <sub>90</sub> = 1 s, T <sub>amb.</sub> = 23°C)	Up to 1500°C: 0.3% of reading in °C + 1°C Above 1500°C: 0.5% of reading in °C	
Repeatability:	0.1% of reading in °C + 1°C (ε = 1, t <sub>90</sub> = 1 s, T <sub>amb.</sub> = 23°C)	
Ambient temperature:	IS 50-LO plus; IGA 50-LO plus: 0 - 60°C on the converter, up to 250°C on side of fiber/ optical head IS 50-Si-LO plus; IS 50-AI-LO plus: 20 - 30°C on the converter, up to 250°C on side of fiber / optical head	
Storage temperature:	-20 to 70°C	
Rel. humidity:	Non condensing conditions	
Sighting:	Laser targeting (max. power level < 1 mW, λ = 630-680 nm, CDRH class II)	
Protection class:	IP65 (DIN 40050)	
Weight:	Converter: 600 g; optical head II: 140 g; fibre (2.5 m): 250 g	
CE-label:	According to EU directives about electromagnetic immunity	



## Features

**Advantages of the digital signal processing:** The signal processing of series 50 pyrometers is fully digital, i.e. the detector signal are digitized immediately and digitally processed. With this technique an extremely high accuracy and repeatability is achieved.

**Accuracy:** The high accuracy is achieved by the digital linearisation of the sensor output as well as the digital compensation for the ambient temperature.

**Temperature range:** Due to the digital technique any temperature sub range within the full temperature range can be set. The analog measuring output corresponds automatically to the selected sub range. This setting of a sub range does not effect the high accuracy and repeatability.

**Output:** The analog measuring outputs 0 - 20 mA or 4 - 20 mA are selectable as well as the serial digital interfaces RS232 or RS485. Additionally the interface allows the controlling of the pyrometer via PC.

**Bus control:** The serial interface RS485 facilitates the integration of the pyrometer into existing field bus systems.

**Calibration:** If necessary a calibration of the pyrometers can be done with help of a PC and a calibration source without opening the housing.



## Optics

Depending on the application the instrument will be delivered with a small or a large optical head. The selection of the optical head depends not only on its size but also on the required spot size (size of the measuring object) and the measuring distance.

### Optical head I:

With the very small dimensions the optical head I is suited for use in confined spaces. The optics is adjusted to one of the measuring distances mentioned in the table. The mentioned spot size will be achieved in exactly this distance (other distances on request).

### Optical head II:



The optics II is bigger, but smaller spot sizes can be achieved. Two designs are available, fixed adjusted or focusable:

Similar to optics I the fixed adjusted type is adjusted to one of the measuring distances mentioned in the table (other distances on request).

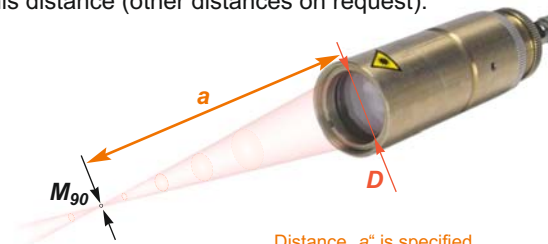
The focusable type is available for 6 different distance ranges. Each measuring distance can be adjusted within the mentioned limits to achieve the smallest spot size in the required distance.



Distance „a“ is specified from the front of the lens

Optical head	Measuring distance a [mm]	Spot size $M_{90}$ [mm]	Aperture D [mm]
<b>Optical head I:</b> 	Adjusted to: 120	1.2	7
	Adjusted to: 260	2.6	7
	Adjusted to: 700	7.2	7
<b>Optical head II: (fixed adjusted)</b> 	Adjusted to: 87	0.45	17
	Adjusted to: 200	0.8	17
	Adjusted to: 600	2.7	15
	Adjusted to: 4500	22	15
<b>Optical head II: (focusable)</b> 	Range: 88 to 110	0.45 to 0.6	17
	Range: 95 to 129	0.5 to 0.75	16
	Range: 105 to 161	0.6 to 1	15
	Range: 200 to 346	0.8 to 1,5	17
	Range: 247 to 606	1.1 to 2.7	16
	Range: 340 to 4500	1.5 to 22	15

## Fiber

The transmission between optical head and converter is done via 0.2 mm mono fiber with a stainless steel protection hose. The optical head contains only the lens, the sensor and the electronics are located in the converter. Fiber and optical head can be used in ambient temperatures up to 250°C without additional cooling (fibre at converter side max. 125°C).

**Minimum bending radius:** for short time (max. 250°C): 50 mm  
 permanent (max. 250°C): 120 mm  
 wound up (max. 50°C): 120 mm

## Dimensions

### Converter:

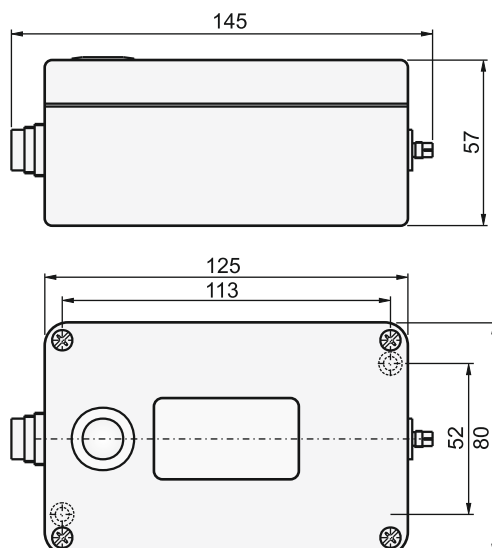

### Optical head type I:

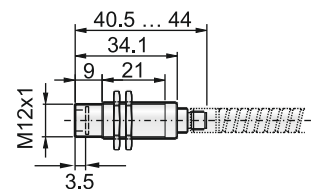

### Optical head type II: (fixed adjusted)

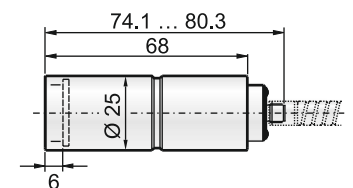

### Optical head type II: (focusable)

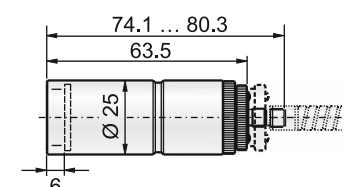

All dimensions in mm

## Reference Numbers

IS 50-LO plus:		
3 882 500	550 to 1400°C	(MB 14)
3 882 520	600 to 1600°C	(MB 16)
3 882 540	650 to 1800°C	(MB 18)
3 882 560	750 to 2500°C	(MB 25)
3 882 580	900 to 3300°C	(MB 33)
3 882 600	550 to 1800°C	(MB 18L)
IS 50/67-LO plus:		
3 882 690	1100 to 3500°C	(MB 35)
IS 50-Si-LO plus:		
3 882 640	500 to 1600°C	(MB 16)
3 882 660	400 to 1300°C	(MB 13)
IS 50-Al-LO plus:		
3 882 840	400 to 1000°C	(MB 10)

IGA 50-LO plus:		
3 882 700	300 to 1300°C	(MB 13)
3 882 720	350 to 1800°C	(MB 18)
3 882 740	450 to 2500°C	(MB 25)
3 882 760	250 to 1350°C	(MB 13,5L)
3 882 780	300 to 2000°C	(MB 20L)
3 882 800	350 to 2500°C	(MB 25L)

### Scope of delivery:

Converter, mono fibre 2.5 m, one selectable optical head (please specify when ordering), works certificate, *InfraWin* operating and analyzing software, user manual.

Note: A connection cable is not included in scope of delivery.

### Accessories:

3 820 330	Connection cable, length 5 m, straight connector	3 834 230	Adjustable mounting support for optical head II
3 820 500	Connection cable, length 10 m, straight connector	3 835 170	Air purge for optical head I
3 820 510	Connection cable, length 15 m, straight connector	3 835 180	Air purge for optical head II
3 820 810	Connection cable, length 20 m, straight connector	3 835 240	90° mirror for optical head II
3 820 820	Connection cable, length 25 m, straight connector	3 852 290	Power supply NG DC for DIN rail mounting; 100 ... 240 V AC ⇒ 24 V DC, 1 A
3 820 520	Connection cable, length 30 m, straight connector	3 890 640	LED digital display DA 4000-N
3 836 400	Fiber, 5 m	3 890 650	LED digital display DA 4000: with 2 limit switches
3 836 410	Fiber, 7.5 m	3 890 560	LED digital display DA 6000-N: with possibility for pyrometer parameter settings for digital IMPAC pyrometers; RS232 interface
3 836 420	Fiber, 10 m	3 890 520	LED digital display DA 6000; DA 6000-N additional with 2 limit switches and analog input and output
3 836 430	Fiber, 15 m	3 826 500	HT 6000, portable battery driven indicator and instrument for pyrometer parameter setting
3 836 440	Fiber, 30 m		
3 834 370	Mounting angle for optical head I (fixed)		
3 834 380	Mounting angle for optical head I (adjustable)		
3 834 390	Ball and socket mounting for optical head I or II		

## Overview Accessories

### Mounting:



### Air purge units:

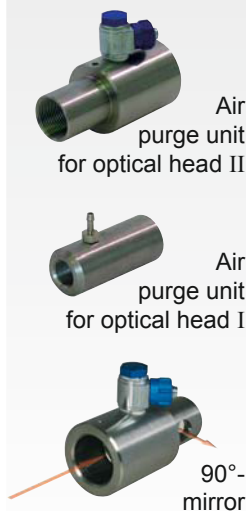

### Digital displays:



### Power supply:



Note: all mechanical accessories are made of stainless steel.

## LumaSense Technologies

### Americas and Australia Sales & Service

3301 Leonard Court  
Santa Clara, CA 95054

Tel.: +1 408 727-1600  
Fax: +1 408 727-1677

[info@lumasenseinc.com](mailto:info@lumasenseinc.com)

### Europe, Middle East, Africa Sales & Service

D-60326 Frankfurt, Germany  
Kleyerstr. 90

Tel.: +49 69 97373-0  
Fax: +49 69 97373-167

### India

Sales & Support Center  
Mumbai, India  
Tel.: +91 22 67419203  
Fax: +91 22 67419201

### China

Sales & Support Center  
Shanghai, China  
Tel.: +86 21 5882 2277  
Fax: +86 21 5887 0077

**SARLIN**

SARLIN OY AB • PL 750, 00101 Helsinki  
Käyntiosoite: Kalivokselantie 3-5, 01610 Vantaa  
Vaihde 010 550 4000 • Fax 010 550 4201  
[info@sarlin.com](mailto:info@sarlin.com) • [www.sarlin.com](http://www.sarlin.com)